



Powerful CAD CAM, Made Easy.



OneCNC XR8

Mill



2.5 Axis



3 Axis



4 Axis



5 Axis

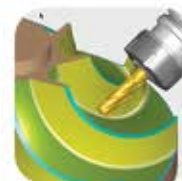

5 Axis Sim



High Speed Machining

OneCNC HS Machining is an industry proven reliable machining method. OneCNC HS Machining is the core of time saving of up to 70% or even more of Roughing Technology. This Technology is applicable to all machines old or new because it has the advantage of utilizing the maximum shank length available of the tool therefore the number of depth cuts are greatly reduced. HS offers unique machining and linking strategies for generating 2D and 3D high speed toolpaths. HS smooths the toolpaths of cutting moves and retracts to maintain a continuous machine tool motion providing maximum efficiency.

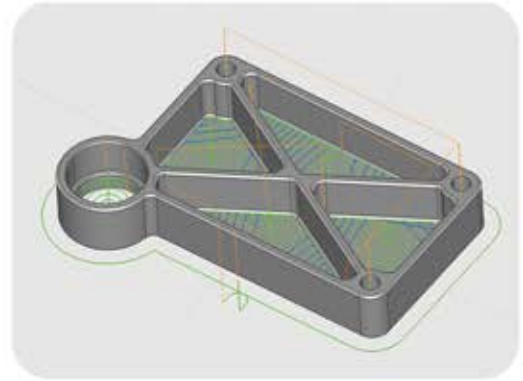

Feature Recognition

No more sorting through holes, our hole wizard with feature recognition will find holes on a part and automatically sort and machine them. Feature recognition system is for hole processing whereby the holes to be processed are automatically recognised and listed for template production. Choose between automatic cycles and your machine tool canned cycles. Complex holes that require multiple cycles and tools can be done in a single step with OneCNC templates. Using the manager, in one step you can spot drill with chamfer, through drill, counter bore, and ream a set of holes.

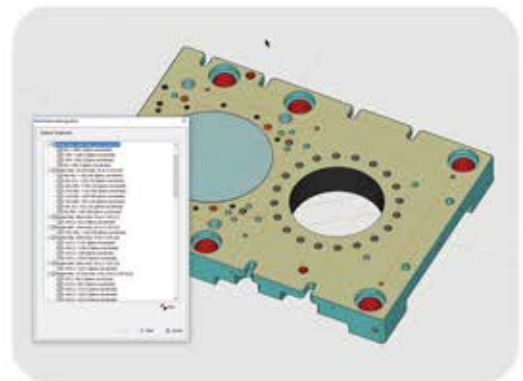

Smart Plane

OneCNC smart plane transforms solid modelling into a simple task. Extrude bosses, create solid cuts, split by plane, model directly on faces and much more. Smart plane revolutionizes 3, 4 & 5 Axis machining allowing users to simply pick a face and machine it simplifying a normally difficult task. OneCNC smart plane allows the construction plane to be set at any position simplifying 3D modelling and the setting of the CAM faces and angles. To machine a face of a multi-axis model it is a simple matter of placing the plane on the face and the CAM rotation angles are automatically configured.

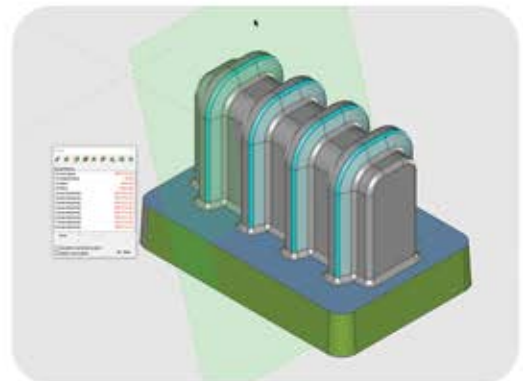

OneCNC Active Cut

OneCNC Active Cut Technology provides fast machining times and benefits of increased cutting tools and machine tool life. OneCNC Active Cut technology actively “looks ahead” allowing the cutter path to machine at optimum speed and accelerating where possible. Smooth vibration free machining is a result with added benefits of extending cutting tool and machine life. Active Cut Technology has been added to all applicable toolpaths in the milling range including pocketing, roughing, and profiling with all versions benefitting from this technology.

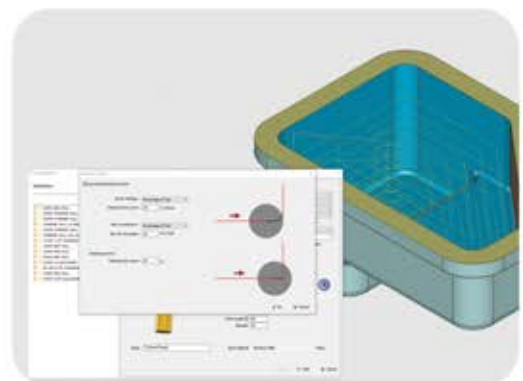



OneCNC 2.5 Axis

OneCNC 2.5D tasks are programmed efficiently and reliably using this very easy to use software. OneCNC 2.5D machining is typically for prismatic or general engineering component manufacture. High Speed and conventional Pocket machining, Z plane level, Profiles, Drill, Tapped or reamed holes, chamfering and corner rounding. Intelligent functionality, such as the recognition of hole features help the CAM user to program faster than ever before. OneCNC high-performance Active Cut technology reduces machining times for all roughing profiling and finishing operations.

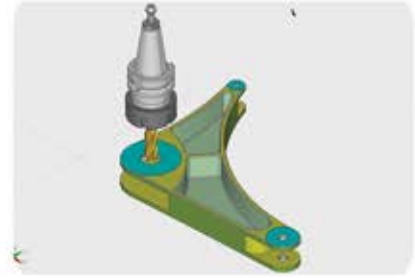

OneCNC 3 Axis

Powerful 3D Machining for Simple and Complex Components. OneCNC software offers powerful and precise functions for 3D milling. OneCNC enables the production of simple and complex components with high-quality surfaces generated quickly, reliably and efficiently. Numerous strategies for roughing and finishing ensure efficient 3D machining. The Wizard Driven toolpaths are calculated with optimized manufacturing times. Advanced facilities of OneCNC Active Cut allow the user to obtain the best performance.

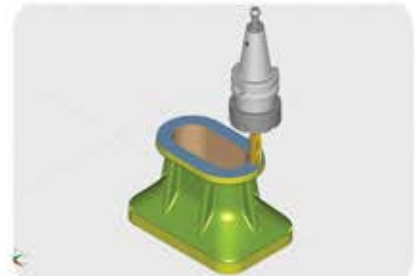

OneCNC 4 Axis Module

Provides the fastest way to increase the productivity of your mill. Adding a single or dual-axis rotary product can reduce or totally eliminate multiple setups, and easily handle multi-sided parts. OneCNC 4 Axis has all the functions of the 2.5 axis and 3 Axis together with 4 Axis simultaneous and wrap machining to provide a complete solution for powerful productivity. Programming is simplified using Smart Plane and efficiency is simplified with OneCNC Active Cut.

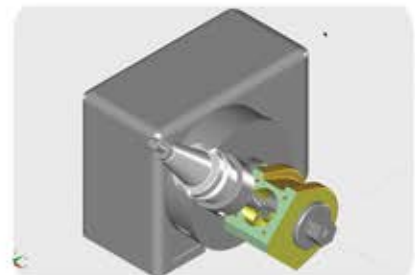

OneCNC 5 Axis Positional Module

Improve your productivity with 5-axis machining capability. OneCNC 5 axis offers a wide range of multi-axis machining strategies basic and advanced to suit even the most complicated parts. OneCNC 5 Axis with advanced Wizard control and smart plane position functionality of the machining simplifies the process. Advanced tool and holder gouge-checking help ensure safe machining in even the most complex parts. OneCNC 5 Axis Positional ensures accurate and fast machining with Active Cut programming for optimum productivity.

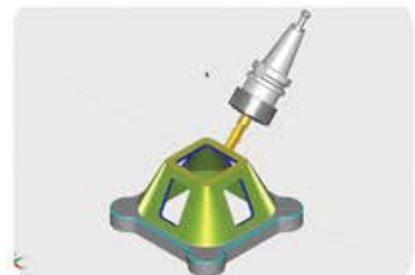

OneCNC 5 Axis Simultaneous Module

Simultaneous 5 axis CAM Technology is one of the most challenging forms of CNC machining, OneCNC software simplifies the process. OneCNC powerful functionality enables users to generate 5-axis programs quickly and easily with reduced machining times. OneCNC simultaneous 5 axis incorporates dynamic toolpath control to assist in smooth machine processing. OneCNC innovative 5-axis technology due to its simple and user-friendly programming technique uses reliable and intelligent algorithms for preview simulation and collision detection.

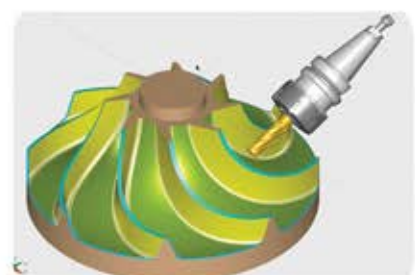

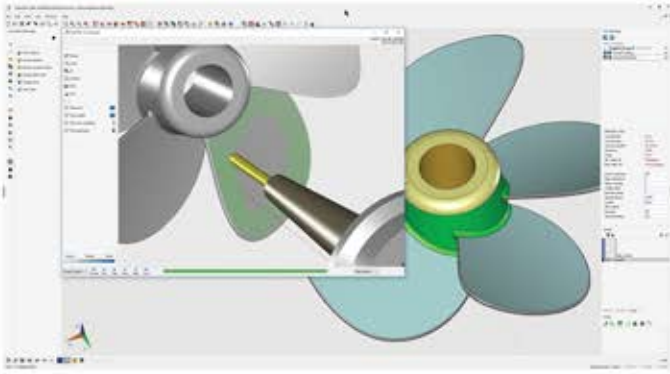

OneCNC Simulation

Accurate and reliable dynamic solid verification and sectioning eliminates the need for expensive dry runs on the machine. High-performance, real-time simulation ensures that even the most complex of parts will be machined correctly. The part program can simulate with a complete chuck, part, fixtures, clamps, and tail stock. Minimize downtime, maximize manufacturing efficiency, and cut machining costs while gaining complete confidence in your machining processes.

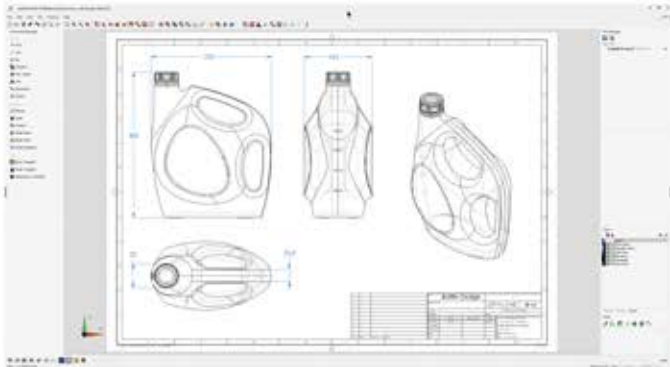

OneCNC Design

OneCNC gives your shop the best possible foundation for shop-tested CAD tools. From wireframe and surfacing with associated dimensioning to solid modelling, OneCNC ensures that you're ready for any job. The streamlined CAD engine makes design work easy because each piece of geometry you create can be incrementally or absolutely created. Combined with all traditional CAD geometry functions consolidated into a few simple clicks, simplifies the creation of even the most complex parts.

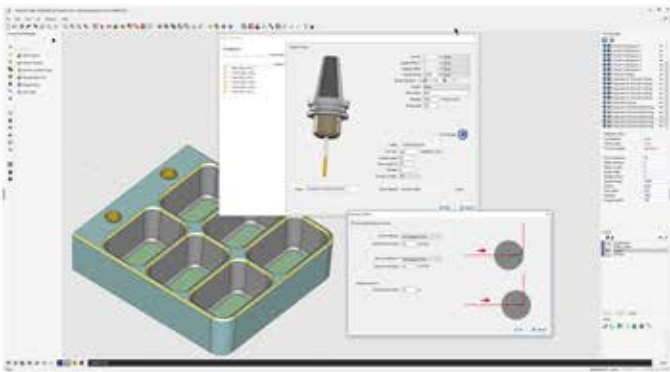

Wizard Driven CAM

Ease of use is a very important factor in creating NC tool paths. OneCNC CAM is "Wizard Driven" to lead users easily through the process with the minimum number of clicks. This ability allows the user to quickly and confidently produce tool paths without missing important settings. Work templates can be saved to further simplify use for commonly used functions.

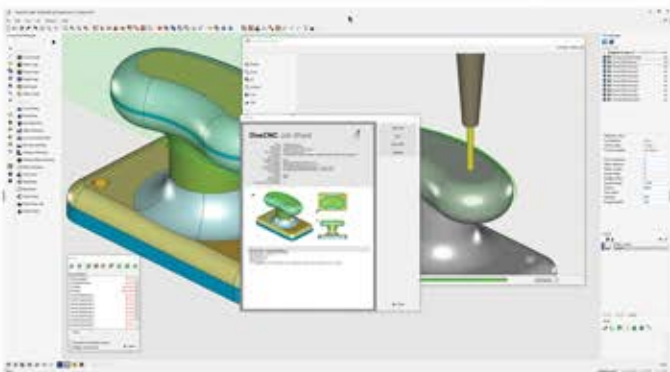

OneCNC Industry 4.0

OneCNC addresses the emerging shift in manufacturing towards Industry 4.0. This ensures users can merge into these goals and have the full benefits of digitalisation. Complete connectivity is provided by way of translators or direct file importation that handles the latest STEP IGES Parasolid SLDPRT SAT 3DM and VADFS to suit Solidworks, Inventor, Rhino3D, Ironcad, Spaceclaim and others. All of these digital processes are necessary to ensure connectivity that comes with Industry 4.0.

OneCNC Global Locations

Australia - USA - USA California - UK - Germany
Benelux - Italy - France - Denmark - Spain - Sweden
Ireland - Poland - Turkey - South Africa - Mexico
Japan - China - Taiwan - Korea - Indonesia - India

More Information:
OneCNC.net

